

# High Efficiency Buck-Boost Regulator with 5.4A Switches

## ISL91110IR

The [ISL91110IR](#) is a high-current buck-boost switching regulator for systems using new battery chemistries. It uses Intersil's proprietary buck-boost algorithm to maintain voltage regulation while providing excellent efficiency and very low output voltage ripple when the input voltage is close to the output voltage.

The ISL91110IR is capable of delivering at least 2A continuous output current ( $V_{OUT} = 3.3V$ ) over a battery voltage range of 2.5V to 4.35V. This maximizes the energy utilization of advanced single-cell Li-ion battery chemistries that have significant capacity left at voltages below the system voltage. Its fully synchronous low ON-resistance 4-switch architecture and a low quiescent current of only 35µA optimize efficiency under all load conditions.

The ISL91110IR supports standalone applications with a fixed 3.3V or 3.5V output voltage or adjustable output voltage with an external resistor divider. Output voltages as low as 1V or as high as 5.2V are supported.

The ISL91110IR requires only a single inductor and very few external components. Power supply solution size is minimized by its 2.5MHz switching frequency, allowing small size external components.

The ISL91110IR is available in a 4mmx4mm, 20 Ld TQFN package.

TABLE 1. KEY DIFFERENCES BETWEEN FAMILY OF PARTS

PART NUMBER	ADJ or FIXED $V_{OUT}$
ISL91110IRNZ-T	3.3
ISL91110IRNZ-T7A	3.3
ISL91110IR2AZ-T	3.5
ISL91110IR2AZ-T7A	3.5
ISL91110IRAZ-T	ADJ
ISL91110IRAZ-T7A	ADJ

## Features

- Accepts input voltages above or below regulated output voltage
- Automatic and seamless transitions between buck and boost modes
- Input voltage range: 1.8V to 5.5V
- Output current: up to 2A ( $P_{VIN} = 3.4V, V_{OUT} = 5V$ )
- Output current: up to 2A ( $P_{VIN} = 2.5V, V_{OUT} = 3.3V$ )
- Burst current: up to 3A ( $P_{VIN} = 2.9V, V_{OUT} = 3.3V, t_{ON} < 600\mu s, t = 4.6ms$ )
- High efficiency: up to 95%
- 35µA quiescent current maximizes light load efficiency
- 2.5MHz switching frequency minimizes external component size
- Fully protected for short-circuit, over-temperature and undervoltage
- Small 4mmx4mm 20 Ld TQFN package

## Applications

- Smartphones and tablet PCs
- Wireless communication devices
- Optical modules networking equipment

## Related Literature

[UG022](#), "ISL91110IRx-EVZ Evaluation Boards User Guide"

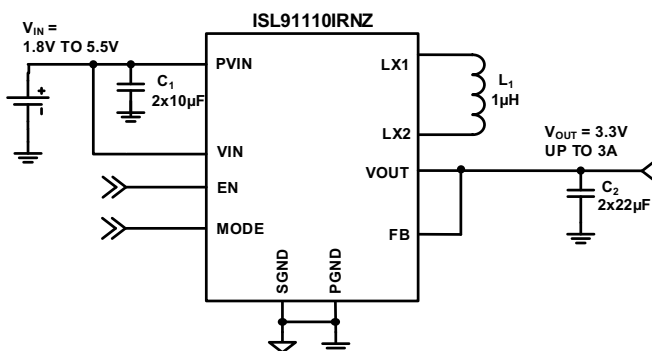

FIGURE 1. TYPICAL APPLICATION:  $V_{OUT} = 3.3V$

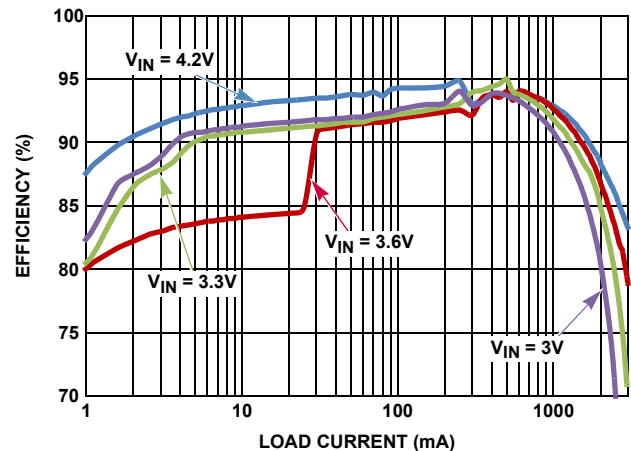
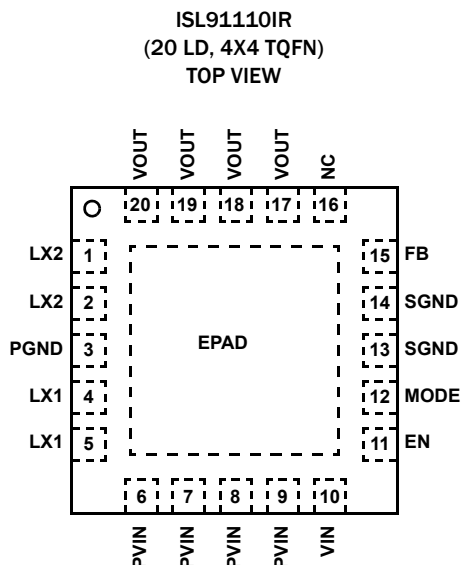

FIGURE 2. EFFICIENCY:  $V_{OUT} = 3.3V, T_A = +25^\circ C$



# ISL91110IR

## Pin Configuration



## Pin Descriptions

PIN #	PIN NAMES	DESCRIPTION
6, 7, 8, 9,	PVIN	Power input; Range: 1.8V to 5.5V. Connect 2x10 $\mu$ F capacitors to PGND.
4, 5	LX1	Inductor connection, input side
3	PGND	Power ground for high switching current
1, 2	LX2	Inductor connection, output side
17, 18, 19, 20	VOUT	Buck-boost regulator output; Connect 2x22 $\mu$ F capacitors to PGND for $V_{OUT} = 3.3V$ and 3.5V applications, and 2x47 $\mu$ F capacitors to PGND for $V_{OUT} = 4.5V$ and 5V applications.
12	MODE	Logic input, HIGH for auto PFM mode. LOW for forced PWM operation. Also, this pin can be used with an external clock sync input. Range: 2.75MHz to 3.25MHz. Do not leave floating.
10	VIN	Supply input; Range: 1.8V to 5.5V.
11	EN	Logic input, drive HIGH to enable device. Do not leave floating.
13, 14	SGND	Analog ground pin
15	FB	Voltage feedback pin, connect directly to the VOUT pin for fixed output voltage versions.
16	NC	No connect pin
	Epad	Thermal pad, connect to PGND

## Ordering Information

PART NUMBER (Notes 1, 2, 3)	PART MARKING	OUTPUT VOLTAGE (V)	TEMP RANGE (°C)	PACKAGE Tape and Reel (RoHS Compliant)	PKG. DWG. #
ISL91110IRNZ-T	91110N	3.3	-40 to +85	20 Ld 4x4 TQFN	L20.4X4C
ISL91110IRNZ-T7A	91110N	3.3	-40 to +85	20 Ld 4x4 TQFN	L20.4X4C
ISL91110IR2AZ-T	911102	3.5	-40 to +85	20 Ld 4x4 TQFN	L20.4X4C
ISL91110IR2AZ-T7A	911102	3.5	-40 to +85	20 Ld 4x4 TQFN	L20.4X4C
ISL91110IRAZ-T	91110A	ADJ	-40 to +85	20 Ld 4x4 TQFN	L20.4X4C
ISL91110IRAZ-T7A	91110A	ADJ	-40 to +85	20 Ld 4x4 TQFN	L20.4X4C
ISL91110IRN-EVZ	Evaluation Board for ISL91110IRNZ				
ISL91110IR2A-EVZ	Evaluation Board for ISL91110IR2AZ				
ISL91110IRA-EVZ	Evaluation Board for ISL91110IRAZ				

### NOTES:

- Please refer to [TB347](#) for details on reel specifications.
- These Intersil Pb-free plastic packaged products employ special Pb-free material sets, molding compounds/die attach materials and 100% matte tin plate plus anneal (e3 termination finish, which is RoHS compliant and compatible with both SnPb and Pb-free soldering operations). Intersil Pb-free products are MSL classified at Pb-free peak reflow temperatures that meet or exceed the Pb-free requirements of IPC/JEDEC J STD-020.
- For Moisture Sensitivity Level (MSL), please see product information page for [ISL91110IR](#). For more information on MSL please see techbrief [TB363](#).

# ISL91110IR

## Absolute Maximum Ratings

PVIN, VIN	-0.3V to 6.5V
LX1, LX2	-0.3V to 6.5V
FB (Adjustable Version)	-0.3V to 2.7V
FB (Fixed V <sub>OUT</sub> Versions)	-0.3V to 6.5V
SGND, PGND	-0.3V to 0.3V
All Other Pins	-0.3V to 6.5V
ESD Rating	
Human Body Model (Tested per JESD22-A114E)	3kV
Machine Model (Tested per JESD22-A115-A)	200V
Charge Device Model	2kV
Latch-up (Tested per JESD-78B; Class 2, Level A)	100mA

## Thermal Information

Thermal Resistance (Typical)	$\theta_{JA}$ (°C/W)	$\theta_{JC}$ (°C/W)
20 Ld 4x4 TQFN Package (Notes 4, 5)	39	4
Maximum Junction Temperature	+125°C	
Storage Temperature Range	-65°C to +150°C	
Pb-Free Reflow Profile	see <a href="#">TB493</a>	

## Recommended Operating Conditions

Ambient Temperature Range	-40°C to +85°C
Supply Voltage Range	1.8V to 5.5V
Max Load Current (V <sub>IN</sub> = 3.4V, V <sub>OUT</sub> = 5V)	2ADC
Max Load Current (V <sub>IN</sub> = 2.5V, V <sub>OUT</sub> = 3.3V)	2ADC
Max Load Current (V <sub>IN</sub> = 2.9V, V <sub>OUT</sub> = 3.3V, t <sub>ON</sub> = 600µs, t = 4.6ms)	3A

**CAUTION:** Do not operate at or near the maximum ratings listed for extended periods of time. Exposure to such conditions may adversely impact product reliability and result in failures not covered by warranty.

### NOTES:

- $\theta_{JA}$  is measured in free air with the component mounted on a high effective thermal conductivity test board with “direct attach” features. See Tech Brief [TB379](#)
- For  $\theta_{JC}$ , the “case temp” location is the center of the exposed metal pad on the package underside.

**Analog Specifications** V<sub>IN</sub> = V<sub>PVIN</sub> = V<sub>EN</sub> = 3.6V, V<sub>OUT</sub> = 3.3V, L1 = 1µH, C1 = 2x10µF, C2 = 2x22µF, T<sub>A</sub> = +25°C. Boldface limits apply across the operating temperature range, -40°C to +85°C and input voltage range (1.8V to 5.5V) unless specified otherwise.

SYMBOL	PARAMETER	TEST CONDITIONS	MIN (Note 6)	TYP (Note 7)	MAX (Note 6)	UNITS
<b>POWER SUPPLY</b>						
V <sub>IN</sub>	Input Voltage Range		<b>1.8</b>		<b>5.5</b>	V
V <sub>UVLO</sub>	V <sub>IN</sub> Undervoltage Lockout Threshold	Rising		1.725	<b>1.775</b>	V
		Falling	<b>1.550</b>	1.650		V
I <sub>VIN</sub>	V <sub>IN</sub> Supply Current	PFM mode, no external load on V <sub>OUT</sub> (Note 8)		35	<b>60</b>	µA
I <sub>SD</sub>	V <sub>IN</sub> Supply Current, Shutdown	EN = SGND, V <sub>IN</sub> = 3.6V		0.05	<b>1.0</b>	µA
<b>OUTPUT VOLTAGE REGULATION</b>						
V <sub>OUT</sub>	Output Voltage Range	ISL91110IRAZ, I <sub>OUT</sub> = 100mA, V <sub>IN</sub> = 3.6V	<b>1.00</b>		<b>5.20</b>	V
	Output Voltage Accuracy	V <sub>IN</sub> = 3.7V, V <sub>OUT</sub> = 3.3V, I <sub>OUT</sub> = 0mA, PWM mode	<b>-2</b>		<b>+2</b>	%
		V <sub>IN</sub> = 3.7V, V <sub>OUT</sub> = 3.3V, I <sub>OUT</sub> = 1mA, PFM mode	<b>-3</b>		<b>+4</b>	%
V <sub>FB</sub>	FB Pin Voltage Regulation	For adjustable output version, V <sub>IN</sub> = 3.6V	<b>0.783</b>	0.80	<b>0.813</b>	V
I <sub>FB</sub>	FB Pin Bias Current	For adjustable output version			<b>20</b>	nA
$\frac{\Delta V_{OUT}}{\Delta V_{IN}}$	Line Regulation, PWM Mode	I <sub>OUT</sub> = 500mA, V <sub>OUT</sub> = 3.3V, V <sub>IN</sub> step from 2.3V to 5.5V		±5		mV/V
$\frac{\Delta V_{OUT}}{\Delta I_{OUT}}$	Load Regulation, PWM Mode	V <sub>IN</sub> = 3.7V, V <sub>OUT</sub> = 3.3V, I <sub>OUT</sub> step from 0mA to 1000mA		±0.005		mV/mA
$\frac{\Delta V_{OUT}}{\Delta V_I}$	Line Regulation, PFM Mode	I <sub>OUT</sub> = 100mA, V <sub>OUT</sub> = 3.3V, V <sub>IN</sub> step from 2.3V to 5.5V		±12.5		mV/V
$\frac{\Delta V_{OUT}}{\Delta I_{OUT}}$	Load Regulation, PFM Mode	V <sub>IN</sub> = 3.7V, V <sub>OUT</sub> = 3.3V, I <sub>OUT</sub> step from 0mA to 100mA		±0.4		mV/mA
V <sub>CLAMP</sub>	Output Voltage Clamp	Rising	<b>5.25</b>		<b>5.95</b>	V
	Output Voltage Clamp Hysteresis			400		mV
<b>DC/DC SWITCHING SPECIFICATIONS</b>						
f <sub>SW</sub>	Oscillator Frequency		<b>2.1</b>	2.50	<b>2.9</b>	MHz
t <sub>ONMIN</sub>	Minimum On Time			80		ns
I <sub>PFETLEAK</sub>	LX1 Pin Leakage Current	V <sub>IN</sub> = 3.6V	<b>-1</b>		<b>1</b>	µA
I <sub>NFETLEAK</sub>	LX2 Pin Leakage Current	V <sub>IN</sub> = 3.6V	<b>-1</b>		<b>1</b>	µA

# ISL91110IR

**Analog Specifications**  $V_{IN} = V_{PVIN} = V_{EN} = 3.6V$ ,  $V_{OUT} = 3.3V$ ,  $L1 = 1\mu H$ ,  $C1 = 2 \times 10\mu F$ ,  $C2 = 2 \times 22\mu F$ ,  $T_A = +25^\circ C$ . **Boldface limits apply across the operating temperature range,  $-40^\circ C$  to  $+85^\circ C$  and input voltage range (1.8V to 5.5V) unless specified otherwise. (Continued)**

SYMBOL	PARAMETER	TEST CONDITIONS	MIN (Note 6)	TYP (Note 7)	MAX (Note 6)	UNITS
<b>SOFT-START AND SOFT DISCHARGE</b>						
$t_{SS}$	Soft-start Time	Time from when EN signal asserts to when output voltage ramp starts.		1		ms
		Time from when output voltage ramp starts to when output voltage reaches 95% of its nominal value with device operating in buck mode. $V_{IN} = 4V$ , $V_{OUT} = 3.3V$ , $I_O = 200mA$		1		ms
		Time from when output voltage ramp starts to when output voltage reaches 95% of its nominal value with device operating in boost mode. $V_{IN} = 2V$ , $V_{OUT} = 3.3V$ , $I_O = 200mA$		2		ms
$R_{DISCHG}$	$V_{OUT}$ Soft-discharge ON-resistance	$EN < V_{IL}$		120		$\Omega$
<b>POWER MOSFET</b>						
$R_{DSON\_P}$	P-channel MOSFET ON-resistance	$V_{IN} = 3.6V$ , $I_O = 200mA$		47		m $\Omega$
		$V_{IN} = 2.5V$ , $I_O = 200mA$		62		m $\Omega$
$R_{DSON\_N}$	N-channel MOSFET ON-resistance	$V_{IN} = 3.6V$ , $I_O = 200mA$		40		m $\Omega$
		$V_{IN} = 2.5V$ , $I_O = 200mA$		55		m $\Omega$
$I_{PK\_LMT}$	P-channel MOSFET Peak Current Limit		<b>4.9</b>	5.4	<b>5.9</b>	A
<b>PFM/PWM TRANSITION</b>						
	Load Current Threshold, PFM to PWM	$V_{IN} = 3.6V$ , $V_{OUT} = 3.3V$		200		mA
	Load Current Threshold, PWM to PFM	$V_{IN} = 3.6V$ , $V_{OUT} = 3.3V$		75		mA
	Thermal Shutdown			155		$^\circ C$
	Thermal Shutdown Hysteresis			30		$^\circ C$
<b>LOGIC INPUTS</b>						
$I_{LEAK}$	Input Leakage	$V_{IN} = 3.6V$		0.05	<b>1</b>	$\mu A$
$V_{IH}$	Input HIGH Voltage	$V_{IN} = 3.6V$	<b>1.4</b>			V
$V_{IL}$	Input LOW Voltage	$V_{IN} = 3.6V$			<b>0.4</b>	V

**NOTES:**

- Parameters with MIN and/or MAX limits are 100% tested at  $+25^\circ C$ , unless otherwise specified. Temperature limits established by characterization and are not production tested.
- Typical values are for  $T_A = +25^\circ C$  and  $V_{IN} = 3.6V$ .
- Quiescent current measurements are taken when the output is not switching.

## Typical Performance Curves

Unless otherwise noted, operating conditions are:  $T_A = +25^\circ\text{C}$ ,  $V_{IN} = EN = 3.6\text{V}$ ,  $L = 1\mu\text{H}$ ,  $C_1 = 2 \times 10\mu\text{F}$ ,  $C_2 = 2 \times 22\mu\text{F}$ ,  $V_{OUT} = 3.3\text{V}$ ,  $I_{OUT} = 0\text{A to } 3\text{A}$ .

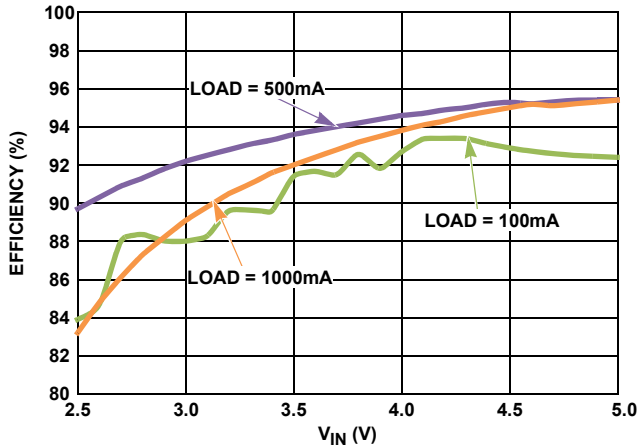

FIGURE 4. EFFICIENCY vs INPUT VOLTAGE ( $V_{OUT} = 5\text{V}$ )

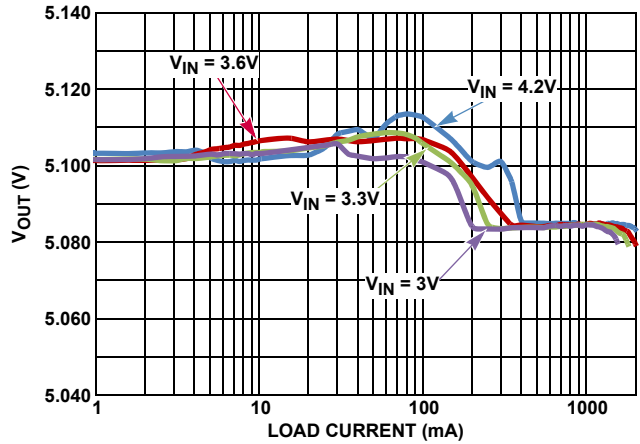

FIGURE 5. OUTPUT VOLTAGE vs LOAD CURRENT ( $V_{OUT} = 5\text{V}$ )

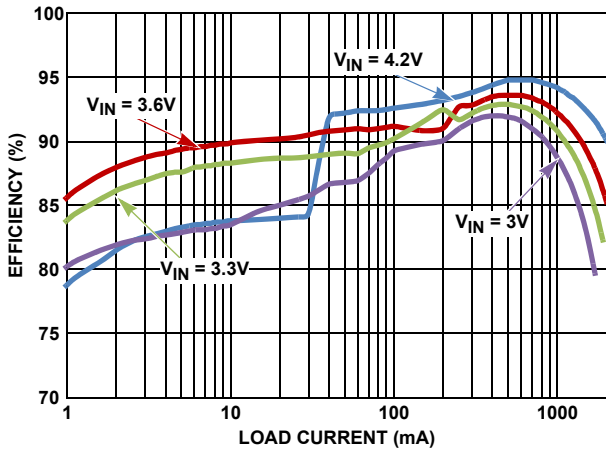

FIGURE 6. EFFICIENCY:  $V_{OUT} = 5\text{V}$ ,  $T_A = +25^\circ\text{C}$

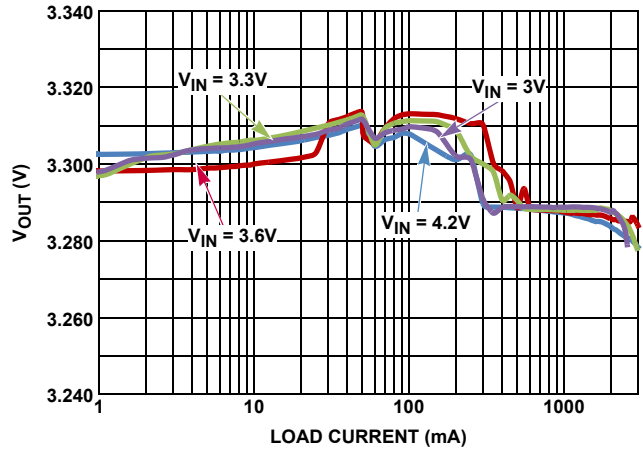

FIGURE 7. OUTPUT VOLTAGE vs LOAD CURRENT ( $V_{OUT} = 3.3\text{V}$ )

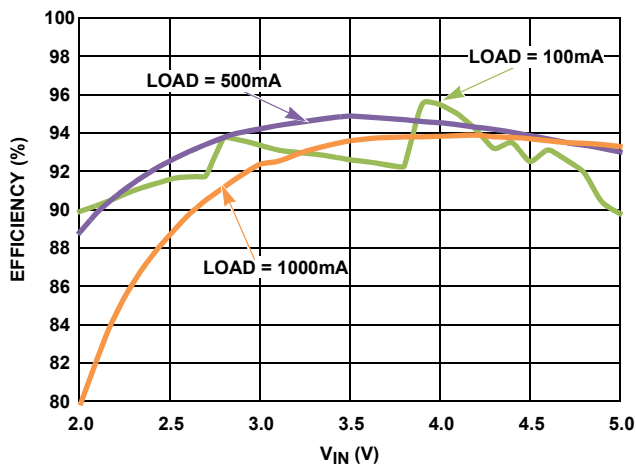

FIGURE 8. EFFICIENCY vs INPUT VOLTAGE ( $V_{OUT} = 3.3\text{V}$ )

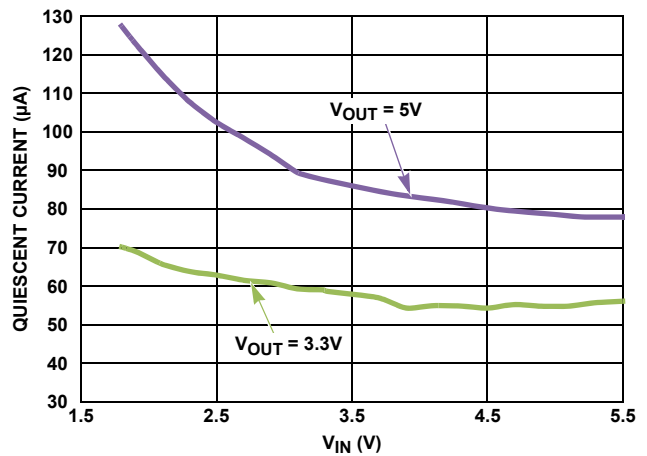

FIGURE 9. QUIESCENT CURRENT vs INPUT VOLTAGE (MODE = HIGH)

## Typical Performance Curves

Unless otherwise noted, operating conditions are:  $T_A = +25^\circ\text{C}$ ,  $V_{IN} = EN = 3.6\text{V}$ ,  $L = 1\mu\text{H}$ ,  $C_1 = 2 \times 10\mu\text{F}$ ,  $C_2 = 2 \times 22\mu\text{F}$ ,  $V_{OUT} = 3.3\text{V}$ ,  $I_{OUT} = 0\text{A}$  to  $3\text{A}$ . (Continued)

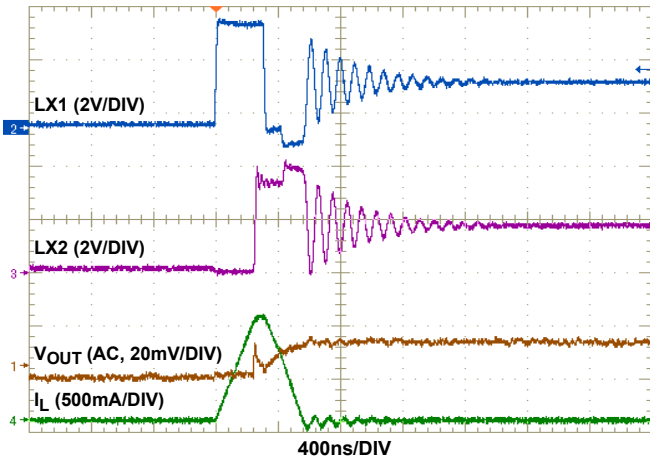

FIGURE 10. STEADY STATE OPERATION IN PFM ( $V_{IN} = 4\text{V}$ ,  $V_{OUT} = 3.3\text{V}$ , NO LOAD)

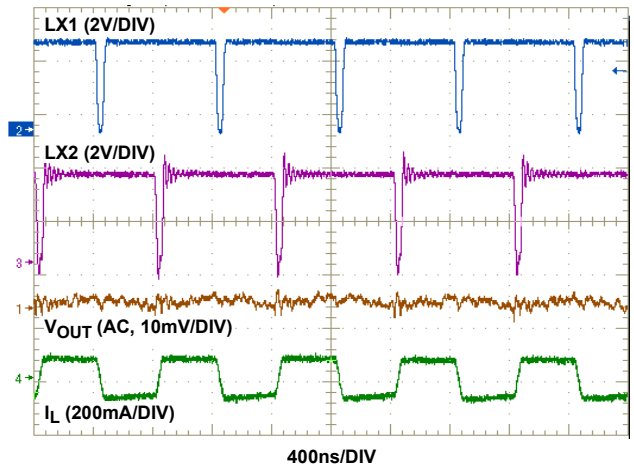

FIGURE 11. STEADY STATE OPERATION IN PWM ( $V_{IN} = 4\text{V}$ ,  $V_{OUT} = 3.3\text{V}$ , NO LOAD)

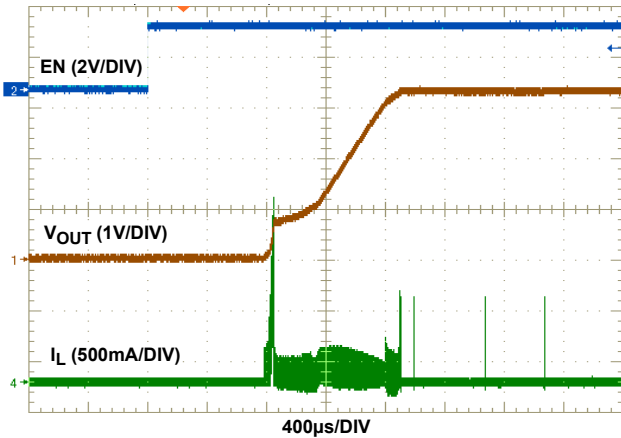

FIGURE 12. SOFT-START ( $V_{IN} = 3.6\text{V}$ ,  $V_{OUT} = 3.3\text{V}$ , NO LOAD)

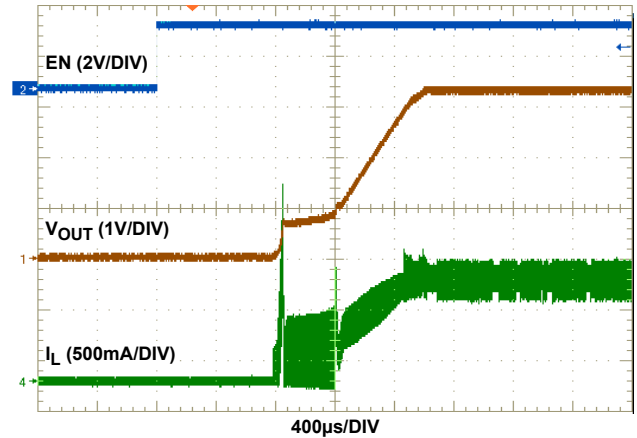

FIGURE 13. SOFT-START ( $V_{IN} = 3.6\text{V}$ ,  $V_{OUT} = 3.3\text{V}$ , 1A RLOAD)

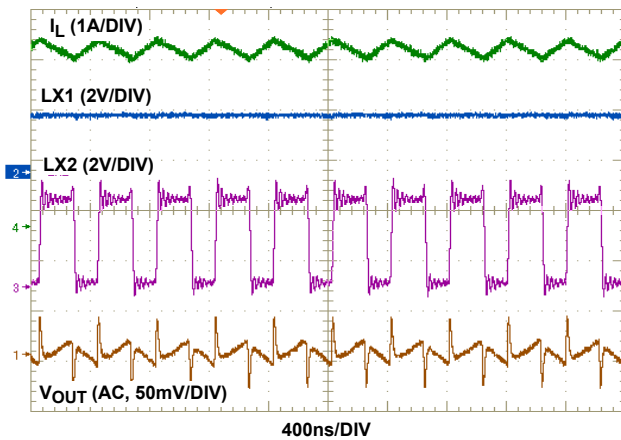

FIGURE 14. STEADY STATE OPERATION ( $V_{IN} = 2.5\text{V}$ ,  $V_{OUT} = 3.3\text{V}$ , 2A LOAD)

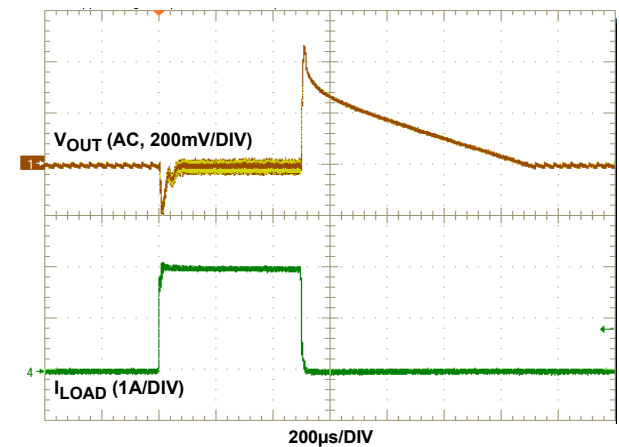

FIGURE 15. 0A TO 2A LOAD TRANSIENT ( $V_{IN} = 3.6\text{V}$ ,  $V_{OUT} = 3.3\text{V}$ )

## Typical Performance Curves

Unless otherwise noted, operating conditions are:  $T_A = +25^\circ\text{C}$ ,  $V_{IN} = EN = 3.6\text{V}$ ,  $L = 1\mu\text{H}$ ,  $C_1 = 2 \times 10\mu\text{F}$ ,  $C_2 = 2 \times 22\mu\text{F}$ ,  $V_{OUT} = 3.3\text{V}$ ,  $I_{OUT} = 0\text{A to } 3\text{A}$ . (Continued)

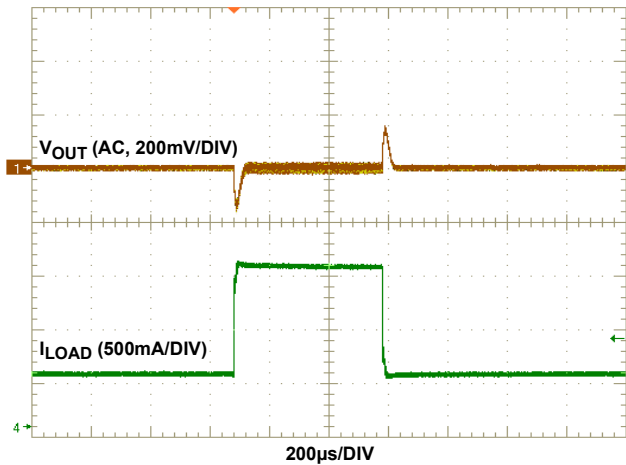

FIGURE 16. 0.5A TO 1.5A LOAD TRANSIENT ( $V_{IN} = 3.6\text{V}$ ,  $V_{OUT} = 3.3\text{V}$ )

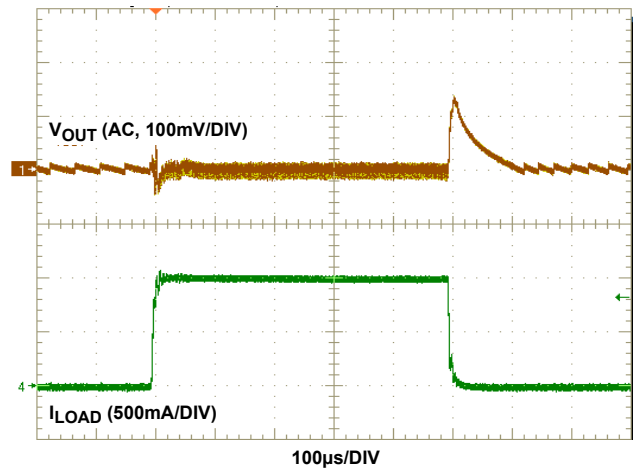

FIGURE 17. 0A TO 1A LOAD TRANSIENT ( $V_{IN} = 3.6\text{V}$ ,  $V_{OUT} = 3.3\text{V}$ )

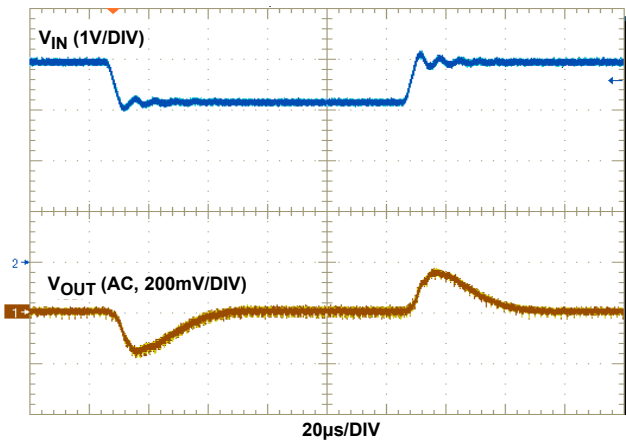

FIGURE 18. 4V TO 3.2V LINE TRANSIENT ( $V_{OUT} = 3.3\text{V}$ ,  $\text{LOAD} = 1\text{A}$ )

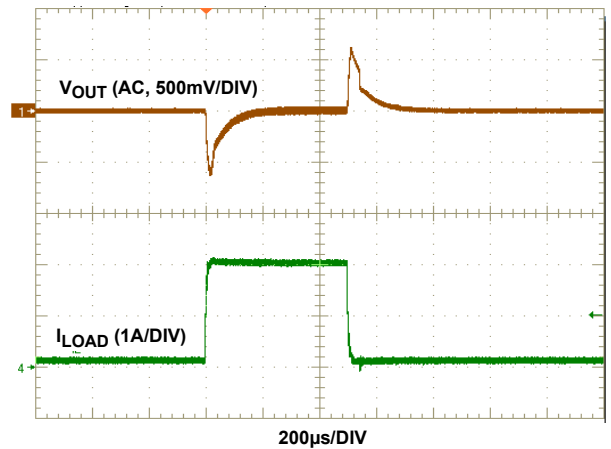

FIGURE 19. 0.1A TO 2A LOAD TRANSIENT ( $V_{IN} = 3.6\text{V}$ ,  $V_{OUT} = 5\text{V}$ )

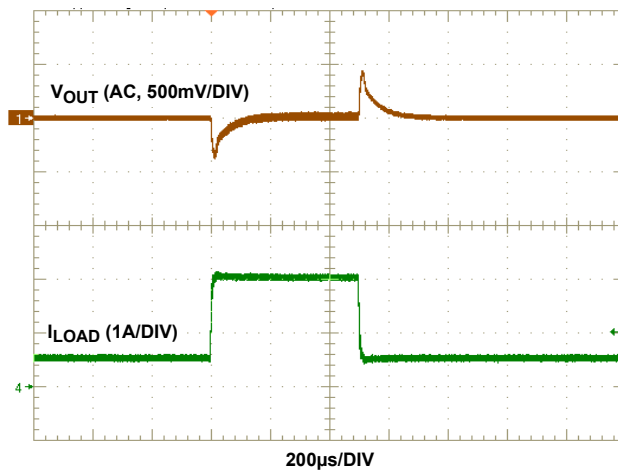

FIGURE 20. 0.5A TO 2A LOAD TRANSIENT ( $V_{IN} = 3.6\text{V}$ ,  $V_{OUT} = 5\text{V}$ )



## Functional Description

### Functional Overview

Refer to the [“Block Diagram” on page 2](#). The ISL91110IR implements a complete buck boost switching regulator, with PWM controller, internal switches, references, protection circuitry and control inputs.

The PWM controller automatically switches between buck and boost modes as necessary to maintain a steady output voltage with changing input voltages and dynamic external loads.

### Internal Supply and References

Referring to the [“Block Diagram” on page 2](#), the ISL91110IR provides four power input pins. The PVIN pin supplies input power to the DC/DC converter, while the VIN pin provides operating voltage source required for stable  $V_{REF}$  generation. Separate ground pins (SGND and PGND) are provided to avoid problems caused by ground shift due to the high switching currents.

### Enable Input

The device is enabled by asserting the EN pin HIGH. Driving EN LOW invokes a power-down mode, where most internal device functions are disabled.

### Soft Discharge

When the device is disabled by driving EN LOW, an internal resistor between VOUT and SGND is activated to slowly discharge the output capacitor. This internal resistor has a typical 120 $\Omega$  resistance.

### POR Sequence and Soft-start

Asserting the EN pin HIGH allows the device to power-up. A number of events occur during the start-up sequence. The internal voltage reference powers up and stabilizes. The device then starts to operate. There is a typical 1ms delay between assertion of the EN pin and the start of switching regulator soft-start ramp.

The soft-start feature minimizes output voltage overshoot and input in-rush currents. During soft-start, the reference voltage is ramped to provide a ramping  $V_{OUT}$  voltage. While the output voltage is lower than approximately 20% of the target output voltage, switching frequency is reduced to a fraction of the normal switching frequency to aid in producing low duty cycles necessary to avoid input in-rush current spikes. Once the output voltage exceeds 20% of the target voltage, switching frequency is increased to its nominal value.

When the target output voltage is higher than the input voltage, there will be a transition from buck mode to boost mode during the soft-start sequence. At the time of this transition, the ramp rate of the reference voltage is decreased, such that the output voltage slew rate is decreased. This provides a slower output voltage slew rate.

The  $V_{OUT}$  ramp time is not constant for all operating conditions. Soft-start into boost mode will take longer than soft-start into buck mode. The total soft-start time into buck operating mode is typically 2ms, whereas the typical soft-start time into boost

mode operating mode is typically 3ms. Increasing the load current will increase these typical soft-start times.

### Short Circuit Protection

The ISL91110IR provides short-circuit protection by monitoring the feedback voltage. When feedback voltage is sensed to be lower than a certain threshold, the PWM oscillator frequency is reduced in order to protect the device from damage. The P-channel MOSFET peak current limit remains active during this state.

### Thermal Shutdown

A built-in thermal protection feature protects the ISL91110IR, if the die temperature reaches +155 $^{\circ}$ C (typical). At this die temperature, the regulator is completely shut down. The die temperature continues to be monitored in this thermal shutdown mode. When the die temperature falls to +125 $^{\circ}$ C (typical), the device will resume normal operation. When exiting thermal shutdown, the ISL91110IR will execute its soft-start sequence.

### Buck-Boost Conversion Topology

The ISL91110IR operates in either buck or boost mode. When operating in conditions where PVIN is close to VOUT, ISL91110IR alternates between buck and boost mode as necessary to provide a regulated output voltage.

[Figure 21](#) shows a simplified diagram of the internal switches and external inductor.

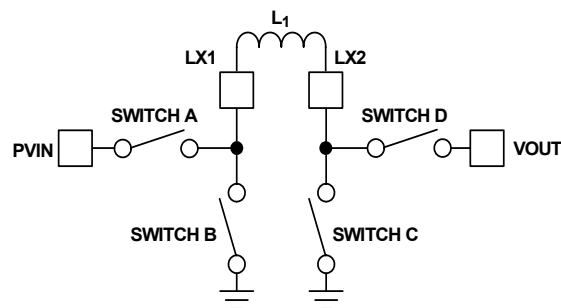

FIGURE 21. BUCK BOOST TOPOLOGY

### PWM Operation

In buck PWM mode, Switch D is continuously closed and Switch C is continuously open. Switches A and B operate as a synchronous buck converter when in this mode.

In boost PWM mode, Switch A remains closed and Switch B remains open. Switches C and D operate as a synchronous boost converter when in this mode.

### PFM Operation

During PFM operation in buck mode, Switch D is continuously closed and Switch C is continuously open. Switches A and B operate in discontinuous mode during PFM operation. During PFM operation in boost mode, the ISL91110IR closes Switch A and Switch C to ramp up the current in the inductor. When the inductor current reaches a certain threshold, the device turns off Switches A and C, then turns on Switches B and D. With Switches B and D closed, output voltage increases as the inductor current ramps down.

In most operating conditions, there will be multiple PFM pulses to charge up the output capacitor. These pulses continue until  $V_{OUT}$  has achieved the upper threshold of the PFM hysteretic controller. Switching then stops and remains stopped until  $V_{OUT}$  decays to the lower threshold of the hysteretic PFM controller.

## Operation With $V_{IN}$ Close to $V_{OUT}$

When the output voltage is close to the input voltage, the ISL91110IR will rapidly and smoothly switch from boost to buck mode as needed to maintain the regulated output voltage. This behavior provides excellent efficiency and very low output voltage ripple.

## Output Voltage Programming

The ISL91110IR is available in fixed and adjustable output voltage versions. To use the fixed output version, the VOUT pin must be connected directly to FB.

In the adjustable output voltage version (ISL91110IRAZ), an external resistor divider is required to program the output voltage. The FB pin has very low input leakage current, so it is possible to use large value resistors (e.g.,  $R_1 = 187k\Omega$  and  $R_2 = 60.4k\Omega$  for  $V_{OUT} = 3.3V$ ) in the resistor divider connected to the FB input.

## Applications Information

### Component Selection

The fixed-output version of ISL91110IR requires only three external power components to implement the buck boost converter: an inductor, an input capacitor and an output capacitor.

The adjustable output version of ISL91110IR requires three additional components to program the output voltage, as shown in [Figure 22](#). Two external resistors program the output voltage and a small capacitor is added to improve stability and response.

## Output Voltage Programming, Adjustable Version

When VREF is connected to SGND, setting and controlling the output voltage of the ISL91110IRAZ (adjustable output version) can be accomplished by selecting the external resistor values.

[Equation 1](#) can be used to derive the  $R_1$  and  $R_2$  resistor values:

$$V_{OUT} = 0.8V \cdot \left(1 + \frac{R_1}{R_2}\right) \quad (\text{EQ. 1})$$

When designing a PCB, include a SGND guard band around the feedback resistor network to reduce noise and improve accuracy and stability. Resistors  $R_1$  and  $R_2$  should be positioned close to the FB pin.

## Feed-Forward Capacitor Selection

A small capacitor ( $C_3$  in [Figure 22](#)) in parallel with resistor  $R_1$  is required to provide the specified load and line regulation. The suggested value of this capacitor is 22pF for  $R_1 = 187k\Omega$ . An NPO type capacitor is recommended.

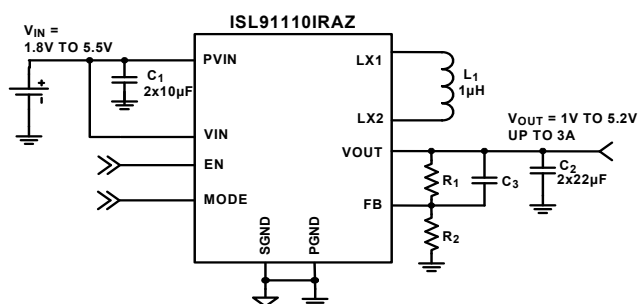

FIGURE 22. ADJUSTABLE OUTPUT APPLICATION

# ISL91110IR

TABLE 2. INDUCTOR VENDOR INFORMATION

MANUFACTURER	MFR. PART NUMBER	DESCRIPTION	DIMENSION (mm)	WEBSITE
Coilcraft	XFL4020-102ME	1 $\mu$ H, 20%, DCR = 10.8m $\Omega$ (typ), Isat = 5.4A (typ)	4x4x2.1	<a href="http://www.coilcraft.com">www.coilcraft.com</a>
Würth Elektronik	7847730	1 $\mu$ H, 20%, DCR = 14m $\Omega$ (typ), Isat = 5.72A (typ)	4x4.5x3.2	<a href="http://www.we-online.com">www.we-online.com</a>

## Inductor Selection

An inductor with high frequency core material (e.g., ferrite core) should be used to minimize core losses and provide good efficiency. The inductor must be able to handle the peak switching currents without saturating.

A 1 $\mu$ H inductor with  $\geq 5.4$ A saturation current rating is recommended. Select an inductor with low DCR to provide good efficiency. In applications where radiated noise must be minimized, a toroidal or shielded inductor can be used.

## PVIN and VOUT Capacitor Selection

The input and output capacitors should be ceramic X5R type with low ESL and ESR. The recommended input capacitor value is 2x10 $\mu$ F. The recommended input capacitor must meet the following requirements: Minimum type is X5R, minimum voltage rating is 16V and minimum case size is 0603. The recommended output capacitor value is 2x22 $\mu$ F for 3.3V and 3.5V V<sub>OUT</sub> applications and 2x47 $\mu$ F for 4.5V and 5V V<sub>OUT</sub> applications. The recommended output capacitor must meet the following requirements: For 22 $\mu$ F, the minimum type is X5R, minimum voltage rating is 10V, and minimum case size is 0603. For 47 $\mu$ F, the minimum type is X5R, minimum voltage rating is 6.3V, and minimum case size is 0603.

TABLE 3. CAPACITOR VENDOR INFORMATION

MANUFACTURER	SERIES	WEBSITE
AVX	X5R	<a href="http://www.avx.com">www.avx.com</a>
Murata	X5R	<a href="http://www.murata.com">www.murata.com</a>
Taiyo Yuden	X5R	<a href="http://www.t-yuden.com">www.t-yuden.com</a>
TDK	X5R	<a href="http://www.tdk.com">www.tdk.com</a>

## Recommended PCB Layout

Correct PCB layout is critical for proper operation of the ISL91110IR. The following are some general guidelines for the recommended layout:

1. The input and output capacitors should be positioned as close to the IC as possible.
2. The ground connections of the input and output capacitors should be kept as short as possible. The objective is to minimize the current loop between the ground pads of the input and output capacitors and the PGND pins of the IC. Use vias, if required, to take advantage of a PCB ground layer underneath the regulator.
3. The analog ground pin (SGND) should be connected to a large/low-noise ground plane on the top or an intermediate layer on the PCB, away from the switching current path of PGND. This ensures a low noise signal ground reference.
4. Minimize the trace lengths on the feedback loop to avoid switching noise pick-up. Vias should be avoided on the feedback loop to minimize the effect of board parasitic, particularly during load transients.

The LX1 and LX2 traces should be short and must be routed on the same layer as the IC.

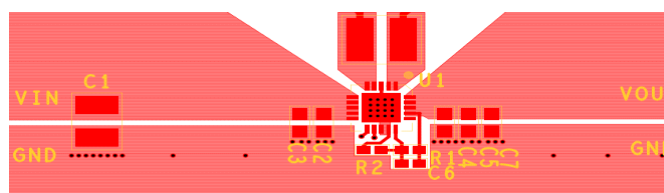

FIGURE 23. RECOMMENDED LAYOUT

## Revision History

The revision history provided is for informational purposes only and is believed to be accurate, but not warranted. Please go to web to make sure you have the latest revision.

DATE	REVISION	CHANGE
April 17, 2015	FN8709.0	Initial Release

---

## About Intersil

Intersil Corporation is a leading provider of innovative power management and precision analog solutions. The company's products address some of the largest markets within the industrial and infrastructure, mobile computing and high-end consumer markets.

For the most updated datasheet, application notes, related documentation and related parts, please see the respective product information page found at [www.intersil.com](http://www.intersil.com).

You may report errors or suggestions for improving this datasheet by visiting [www.intersil.com/ask](http://www.intersil.com/ask).

Reliability reports are also available from our website at [www.intersil.com/support](http://www.intersil.com/support)

For additional products, see [www.intersil.com/en/products.html](http://www.intersil.com/en/products.html)

---

Intersil products are manufactured, assembled and tested utilizing ISO9001 quality systems as noted in the quality certifications found at [www.intersil.com/en/support/qualandreliability.html](http://www.intersil.com/en/support/qualandreliability.html)

---

*Intersil products are sold by description only. Intersil Corporation reserves the right to make changes in circuit design, software and/or specifications at any time without notice. Accordingly, the reader is cautioned to verify that data sheets are current before placing orders. Information furnished by Intersil is believed to be accurate and reliable. However, no responsibility is assumed by Intersil or its subsidiaries for its use; nor for any infringements of patents or other rights of third parties which may result from its use. No license is granted by implication or otherwise under any patent or patent rights of Intersil or its subsidiaries.*

---

For information regarding Intersil Corporation and its products, see [www.intersil.com](http://www.intersil.com)

---

## Package Outline Drawing

### L20.4x4C

20 LEAD QUAD FLAT NO-LEAD PLASTIC PACKAGE

Rev 0, 11/06

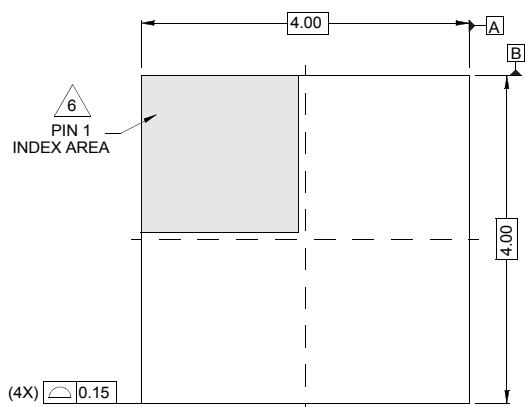

TOP VIEW

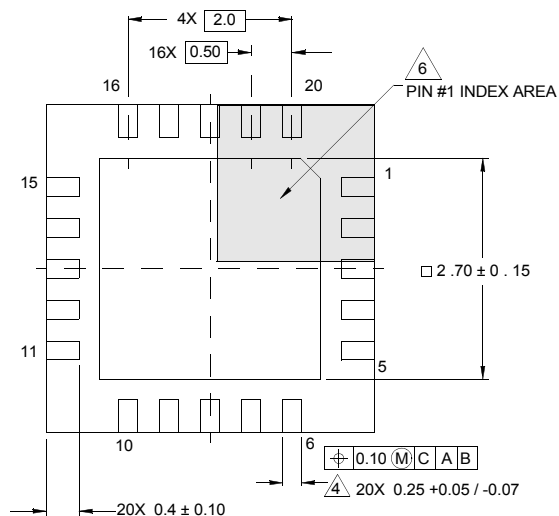

BOTTOM VIEW

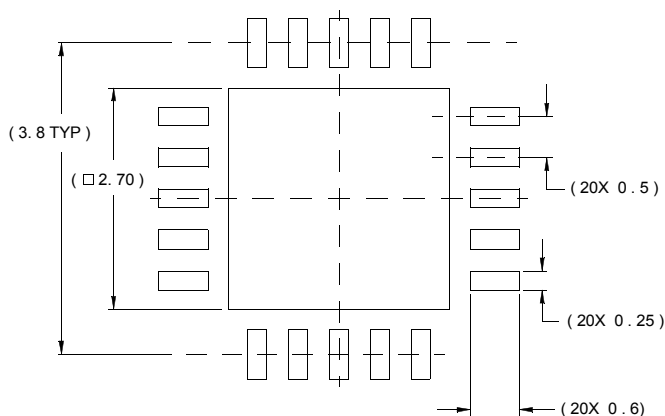

TYPICAL RECOMMENDED LAND PATTERN

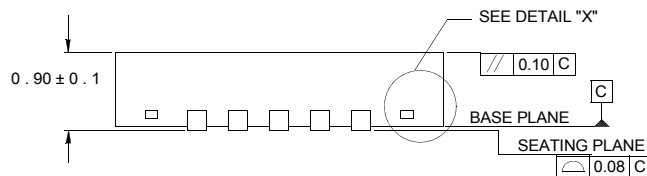

SIDE VIEW

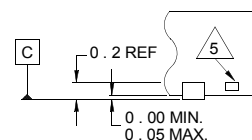

DETAIL "X"

#### NOTES:

1. Dimensions are in millimeters.  
Dimensions in ( ) for Reference Only.
2. Dimensioning and tolerancing conform to AMSE Y14.5m-1994.
3. Unless otherwise specified, tolerance : Decimal  $\pm 0.05$
4. Dimension b applies to the metallized terminal and is measured between 0.15mm and 0.30mm from the terminal tip.
5. Tiebar shown (if present) is a non-functional feature.
6. The configuration of the pin #1 identifier is optional, but must be located within the zone indicated. The pin #1 identifier may be either a mold or mark feature.